



GalcoGunleather.com
 Facebook.com/galcoGUNleather.com
 Twitter.com/galcoGUNleather.com
 YouTube.com/galcoGUNleather.com
 Instagram.com/galcoGUNleather.com
 Pinterest.com/galcoGUNleather.com



Galco Customer Service can be reached
 Toll Free at 800-874-2526
 or by Email at:
 customerservice@galcoGUNleather.com



PRODUCT INFORMATION GUIDE KINGTUK SERIES / QUICKTUK CLOUD IWB HOLSTERS

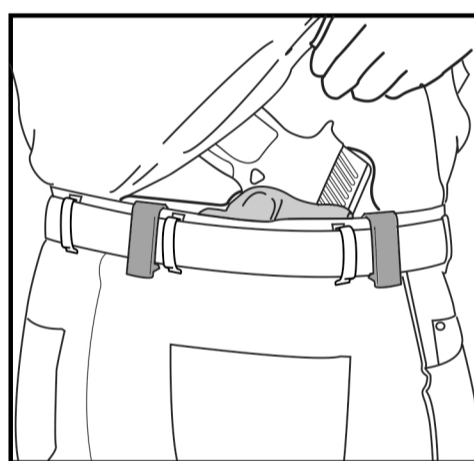

GalcoGunleather.com
 2019 West Quail Avenue Phoenix Arizona 85027

SAFETY SYMBOL DEFINITIONS

⚠ DANGER

Indicates a hazardous situation which, if not avoided, will result in death or serious injury.

⚠ WARNING

Indicates a hazardous situation which, if not avoided, could result in death or serious injury.

⚠ CAUTION

Indicates a hazardous situation which, if not avoided, could result in minor or moderate injury.

NOTICE

Used to address practices unrelated to potential personal injury.



Visit GalcoGunleather.com/videos to view related safety videos.

IMPORTANT SAFETY WARNINGS AND INSTRUCTIONS READ PRIOR TO USING GALCO PRODUCTS

⚠ DANGER

Firearms users must understand and obey the Rules of Firearms Safety:

1. All firearms are always loaded.
2. Never let the muzzle cover anything you're not willing to destroy.
3. Keep your finger off the trigger until your sights are on target.
4. Be sure of your target and what's beyond.

⚠ WARNING Failure to heed these warnings or follow the operating instructions may result in negligent discharge of a firearm, causing serious injury or death.

Read and understand all owner's manuals, instructions, and guides prepared by the manufacturer of your firearm prior to use.

Galco holsters are designed to carry specific firearms.

⚠ WARNING Before use, be sure the holster selected is designed and intended to carry your particular firearm.

If you have any questions about correct fit, contact Galco Customer Service at 800-874-2526 or customerservice@galcoGUNleather.com.

You may also visit GalcoGunleather.com and use our online "shop by gun" feature.

⚠ WARNING Carrying a firearm in an ill-fitting or improper holster can result in serious injury or death. The purchase and use of a Galco holster is at the sole and exclusive risk of the user.

READ AND UNDERSTAND THIS ENTIRE GUIDE PRIOR TO USING THIS PRODUCT

Firearms are inherently dangerous. Improper or careless use of a firearm or firearm and holster may result in serious injury or death. It is the user's responsibility to possess a thorough knowledge of, and be properly trained in, all aspects of firearm use, including holster use and safety.

⚠ WARNING Do not place a loaded firearm in a holster without first testing – with a firearm double-checked and verified to be unloaded – for a proper firearm fit.

⚠ CAUTION Tension units are not pre-set at the factory. If a holster has tension units, it is the user's responsibility to ensure they are appropriately adjusted to appropriately retain the firearm.

Carry the firearm in the safe condition recommended by its manufacturer. This information will be contained in the product information manual provided by the firearm manufacturer. If you do not have the manual applicable to the firearm, contact the firearm's manufacturer.

Always ensure the firearm is fully seated in the holster, and that it activates all automatic or manual retention devices (when provided). Retention devices must be used when provided.

⚠ WARNING If the firearm is not properly secured by means of friction or the retention device(s), it could become dislodged, causing injury and possibly death to the user and others.

⚠ WARNING Never holster a firearm in the single-action m mode, unless it is a semi-automatic pistol and holster designed and intended for "cocked and locked" or "Condition One" carry.

⚠ WARNING Always ensure that a single-action pistol carried in "Condition One" has the manual safety engaged when carrying in a holster.

⚠ WARNING Do not attempt to cock a holstered firearm as this may damage the firearm, the holster, or both, and may contribute to a negligent discharge.

⚠ WARNING Always protect an exposed magazine release from accidental activation.

⚠ WARNING When drawing a firearm from the holster, DO NOT place your finger on the trigger, in the trigger guard, or near the trigger. Position your finger along the frame of the firearm, above the trigger guard. Keep your finger off the trigger until your sights are on target. 🚫

⚠ WARNING A significant number of negligent discharges – some resulting in injury or death – occur while holstering a firearm. Most are caused by the user's index finger pressing the trigger. Some are caused because a foreign object becomes entangled or trapped in the trigger guard/holster and presses the trigger.

The safest practice is to "look the firearm into the holster." This should be done methodically and without rushing. While holstering, be fully cognizant that:

1. All safeties are engaged.
2. Your index finger is straight along the firearm's frame. DO NOT place your finger on the trigger, in the trigger guard, or near the trigger. Keep your finger off the trigger until your sights are on target.
3. No articles of clothing (shirt tails, jacket drawstrings, etc.) become trapped in the trigger guard, holster, or between the firearm and holster.
4. Your shooting-hand thumb is placed over the hammer or the rear of the slide. This will enable you to feel if the hammer starts to move rearward or the slide begins to come out of battery.
5. You strictly observe Rule of Firearms Safety #2: never let the muzzle cover anything you're not willing to destroy. If you do not know how to holster your firearm without breaking this rule, you should seek training before holstering your firearm while the holster is worn.
6. If for any reason you are unable to "look the firearm into the holster" and not muzzle yourself or others, you should remove the holster from your body, then "look the firearm into the holster" (without breaking Rule #2). After the firearm is securely seated in the holster, attach the holster to your body/clothing in the manner in which it was designed.
7. If you holster your firearm while the holster is off and in your hand, insure you do NOT point the firearm at your support hand. Do not place your support hand (or other body parts) at the bottom of the holster. The holster material is not bullet proof. Neither your support hand, other body parts, nor other people should be muzzled/flagged while holstering. 🚫

⚠ WARNING If a firearm falls out of its holster, it may fire, causing death or serious injury.

Always place your hand on the firearm and holster when running or performing other physically vigorous activities.

It is the user's responsibility to maintain the holster by regularly checking component parts for excessive wear and proper function. This includes, but is not limited to, tension units, snap closures and retention devices.

Checking tension units each time the holster is used is required as part of your regular safety inspection. Applying a small amount of clear nail polish to the threads of the tension units, after proper adjustment, will help minimize screw loosening.

⚠ WARNING Do not use customized, modified, worn or broken firearms, or those otherwise outside the original manufacturer's specifications, in a Galco holster.

Do not in any way modify, disassemble, or remove any part from this holster, except as approved and recommended in Galco's Product Information Guide.

Do not rely on any holster being "snatch proof" regardless of the number of retention devices it may feature. Rely only on proper training and situational awareness.

CARRY CONDITION OF THE FIREARM

⚠ WARNING Some single-action revolvers and some semi-automatic pistols must be carried with the hammer or firing pin resting on an empty chamber.

Carrying any firearm with a live cartridge in the chamber immediately in front of the firing pin may cause a negligent discharge. Information regarding the safe carry condition of your firearm will be contained in the product information manual provided by the firearm's manufacturer. If you are unsure of the safe carry condition(s) of your firearm, contact the firearm's manufacturer.

⚠ WARNING Galco holsters with retention straps intended for single-action pistols (such as the 1911) are designed for "hammer down, empty chamber" carry, unless otherwise specified. Galco holsters without retention straps (open top) are designed to carry single-action pistols in all safe conditions of carry as specified by the firearm manufacturer.

IF ANY DOUBT EXISTS AS TO THE SERVICEABILITY OR SAFETY OF A GALCO PRODUCT, IMMEDIATELY CEASE USING IT

**If you have questions, contact:
 Galco Customer Service at 800-874-2526
 or customerservice@galcoGUNleather.com.**

Galco has made every effort to properly label all holsters for the specific firearms they fit. However, firearms manufacturers often make changes to their firearms that affect holster fit.

Galco will not be responsible for such changes, nor for typographical or other human errors that may occur. It is the user's responsibility to ensure proper holster fit with actual firearms.

It is important to understand that all products, including firearms and holsters, may eventually "wear out" or become unsuitable for the function for which they were designed. Stress and strain placed on a product will vary according to frequency and conditions of use, and therefore it is difficult to indicate a recommended replacement date for this product.

INSPECTIONS / MAINTENANCE, ADDITIONAL USER RESPONSIBILITIES

NOTICE It is the user's responsibility to ensure that the item remains serviceable and safe, and able to continue service within its design intent.

⚠ WARNING It is the user's responsibility to inspect the holster before and after each use for signs of excessive wear or loss of retention capability, and appropriate tightness of all hardware.

PRODUCT IDENTIFICATION

Galco products are generally identified with a two-part code stamped into the holster body or label affixed to the item.

An alphabetical or alphanumeric prefix identifies the holster model. For example, the FLETCH model's prefix is FL while the Royal Guard's prefix is RG.

The numerical suffix identifies the particular firearm the holster is intended to fit. For example, the 212 suffix indicates a 5" 1911 while the 224 suffix indicates a Glock 17. The letter "B" or "H" at the end of the code indicates color. B is for black, H for havana brown, while no letter generally indicates tan.

Thus, an FL212 (FL + 212 + no letter) will be a tan FLETCH to fit a 5" 1911, while an RG224B (RG + 224 + B) will be a black Royal Guard for a Glock 17.

Holsters intended for Galco's modular shoulder systems display letters and numbers that correspond to guns. A Miami Classic holster intended for a SIG P320, for example, will simply read 820. A VHS holster intended for a Beretta 92FS will read V202.

The numerical suffix of holsters intended for right-hand or ambidextrous use will end in an even number. The suffix of holsters intended for left-hand use will end in an odd number.

You may use the "search by gun" feature found at our website, GalcoGunleather.com, to locate a holster fit. Simply enter the model number on the item (FL224B, for example) in the field. Should you have questions regarding the identification of the firearm intended for your Galco product, you may also contact Galco's customer service department at 800-874-2526 (during business hours) or by email at customerservice@galcoGUNleather.com.

⚠ WARNING A small number of Galco holsters are approved for use with multiple firearms. Care must always be taken to ensure your holster is an appropriate and approved fit for your firearm. Never carry a firearm in any holster not specifically recommended by Galco for that firearm.

THANK YOU FOR YOUR PURCHASE OF A GALCO PRODUCT! WE APPRECIATE YOUR BUSINESS.

KINGTUK SERIES /QUICKTUK CLOUD

Galco's highly popular QuickTuk™ and KingTuk™ series of tuckable IWB holsters reign supreme in comfort, speed, and versatility! The backplate rides comfortably on the body and quickly conforms to the wearer's hip while the rigid Kydex® holster pocket provides a fast draw and easy holstering.

The QuickTuk/KingTuk series includes Galco's patent-pending polymer UniClip™, while KingTuk models also include the Ultimate Stealth™ clip. The clips are designed for excellent concealment, stability and easy on-off capability and can be moved up or down in corresponding holes in the backing plate, enabling the user to set the carry angle and/or height to suit their unique preferences.

KINGTUK DELUXE IWB HOLSTER

Galco's KingTuk Deluxe IWB combines a stable Premium Steerhide™ backing plate which is lined with Premium Center Cut Steerhide™ for comfort.

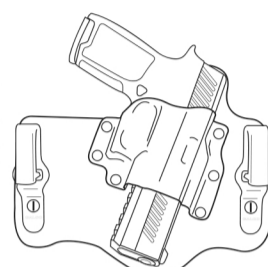

KINGTUK AIR IWB HOLSTER

The ventilated Premium Steerhide backing plate of the KingTuk Air™ provides a level of comfort previously unknown with broad-plated IWB holsters - especially in hot or humid climates.

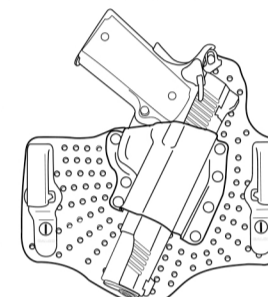

KINGTUK CLASSIC

The KingTuk Classic brings the ultimate in deep concealment with a smooth single-layer backing plate made from Premium Steerhide.

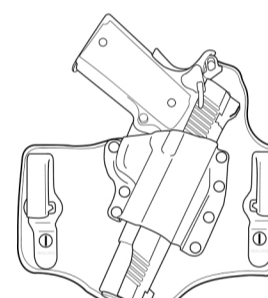

QUICKTUK CLOUD

The QuickTuk Cloud™ IWB holster's outstanding comfort level comes from its innovative backing plate, composed of a ballistic nylon front over a closed cell foam body. The portion of the plate that rides against the wearer is lined with Galco's Comfort Cloth™, which provides padding and wicks moisture.

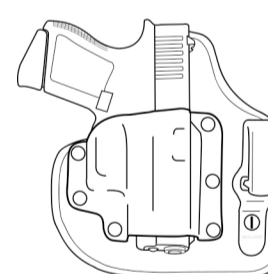

DO

⚠ WARNING
Keep your finger off the trigger until your sights are on the target!!

NOTICE
Full grain leather holsters that come in contact with bodily perspiration, the elements, or become soiled on a regular basis may need to be treated periodically to slow the natural breakdown of the leather fibers. Dry the leather naturally, without any type of artificial heat. Use Galco Leather Lotion, which will replace the natural oils in the leather.

To clean Kydex, dust with a soft damp cloth and wipe surface gently while being careful to avoid wetting the leather backplate. A soft plastic brush, such as a toothbrush, may be used to loosen light dirt. After dampening, be sure to dry surface to avoid streaking or water spots.

Clean synthetic material as needed by hand using a soft bristle brush. If additional cleaning is needed, wash by hand with a mild soap and water. Allow to air dry naturally.

DON'T

NOTICE
Do not place a loaded firearm in a holster without first testing – with a firearm double-checked and verified to be unloaded – for proper firearm fit.

Do not store your firearm in a holster if the holster is damp from perspiration or in otherwise moist condition.

Do not use LocTite® or threadlock. Out-gassing from these adhesive compounds will adversely affect plastic, nylon and rubber holster parts.

Do not submerge or saturate your leather product in water or any other liquid or dry your leather product with heat from a dryer, oven, radiator, direct sunlight, etc.

Do not use products such as Neats Foot or Mink oil, as they will damage the leather. Additionally, do not use Galco Leather Lotion or other leather conditioners on Premium Center Cut Steerhide.

Do not leave your Galco product on the dashboard of your car in summer, or leave it otherwise exposed to the elements.

CARE, MAINTENANCE AND STORAGE

NOTICE
Dirt and grit trapped in your holster may harm your firearm's finish. To clean your holster, especially after use in dusty conditions, simply wipe out the interior of the holster using a clean, damp cloth.

NOTICE
The above care and maintenance instructions cannot substitute for your good common sense. Following our recommended care and maintenance tips, along with common sense, will allow you to get the maximum service life from your Galco products.

HOLSTER FIT / BREAK-IN

Galco's full grain leather holsters are made of the finest materials and are precision molded to specific firearms. It may appear the holster fit is too tight at first, but this is by design. We engineer our holsters to fit tightly knowing the leather fibers will relax to the proper fit with use.

⚠ WARNING UNLOAD YOUR FIREARM
(chamber, magazine, cylinder) before testing holster fit.

If the holster has screws: Screws are not pre-set at the factory. You may need to adjust them in order to properly secure any belt clips. We recommend that you check your screw adjustments before each use. A single drop of clear nail polish applied to your screw threads may reduce its unwanted loosening.

If the fit is too tight when holstering your firearm the first time don't force it. If you do force the firearm into the holster, it may be very difficult to remove. Instead, follow these simple steps to break in your new holster using a process called blocking:

- 1 Place the unloaded firearm in a plastic freezer bag, or cover it in 2-3 layers of plastic kitchen wrap. Do not cover the grip.
- 2 Insert the bagged/wrapped firearm slowly into the holster, gently twisting it side-to-side to minimize tearing of the bag/wrap.
- 3 Once the firearm is completely seated in the holster, twist it approximately 1/16" in both directions 6-12 times.
- 4 Allow the bagged/wrapped firearm to sit in the holster for approximately 15 minutes.
- 5 Remove the firearm from the holster and remove the bag/wrap from the firearm.
- 6 Insert the unloaded firearm into the holster, which should now be snug but not loose. If it is still too tight, repeat the above steps until the holster is broken in to your satisfaction.

HOLSTER FIT / BREAK-IN (continued)

Following and repeating the holster fit/break-in instructions is the only way to an ideal break-in and long service life with proper fit that will last many years.

It is common for the inside of a leather holster to scratch from a single holstering (called etching). A smooth leather lined holster will be even more subject to this normal occurrence. After this initial etching, the holster will custom fit your firearm.

Some modern pistols have very sharp edges, particularly surrounding the ejection port. This may cause an initial feeling of "dragging" on the draw, but will normally resolve quickly with just a few draw-and-holster repetitions.

Try our Draw-Ez™ applied to the inside of your leather holster to shorten the break-in period and provide a slicker draw. Draw-Ez only treats the interior surface of the leather and will not be absorbed by the leather or harm the finish.

TUCKABLE CLIPS

The KingTuk series allow for customization of ride height and angle of carry by installing any of the included or optional clips in the corresponding holes in the leather. Ensure that screws are tightened snugly after adjustment.

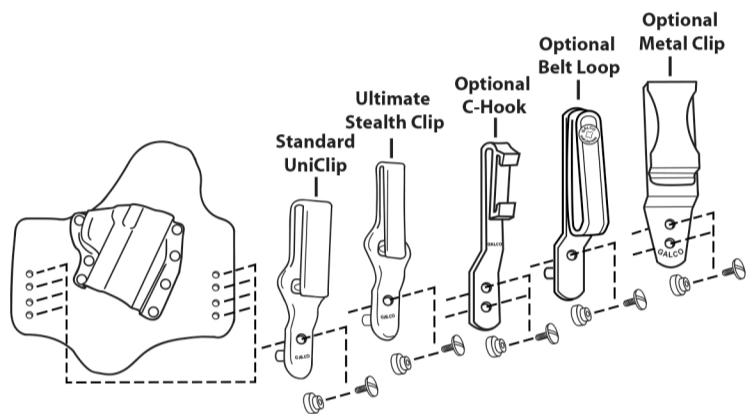

With your shirt tail outside your pants, put the holster inside your pants with the clip over the pants and belt. The shirt may be tucked in over the gun and holster to completely conceal the handgun.

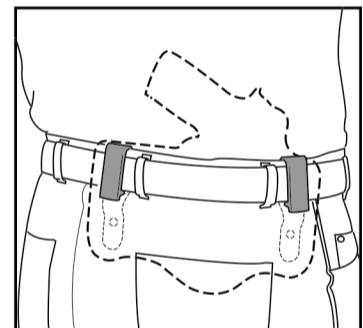

Shown with UniClip

To draw, lift the tucked-in shirt with the support hand, then grasp the pistol with the shooting hand.
*Shown with UniClip

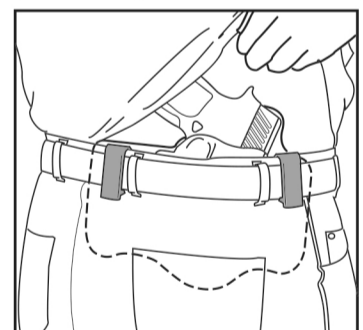

KINGTUK CLASSIC TUCKABLE CLIPS

The Ultimate Stealth Clip (see illustration A) fits over the trouser waistband, under/behind a belt. The Ultimate Stealth Clip is compatible with unlimited belt widths.

The UniClip (see illustration B) is designed to go over the belt. The UniClip fits belts up to 1 1/2" wide.

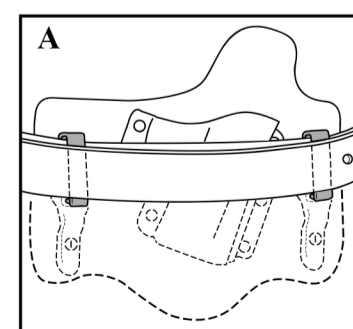

Ultimate Stealth Clip

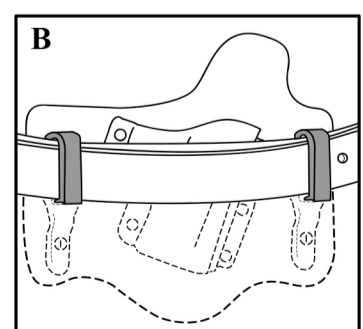

UniClip

ACCESSORIES

The tuckable belt loops are constructed from an injection molded polymer tab mated to a leather belt loop with a snap closure (see illustration C). The leather loops will fit belts up to 1 1/4" wide.

The tuckable C-Hooks feature injection molded plastic (see illustration D). A belt up to 1 1/4" wide is quickly and easily threaded through the C-Hooks. The belt MUST be threaded onto the clip.

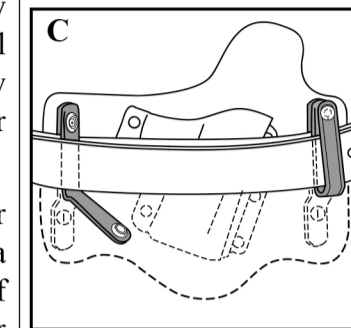

Belt Loops

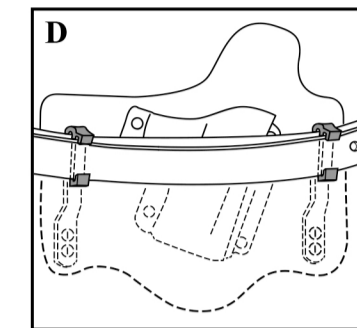

C-Hooks

⚠ CAUTION
Screws are not pre-set at the factory. It is the users responsibility to ensure they are appropriately adjusted to properly retain the firearm.

REPAIRS

Great care was taken to select the finest materials available to craft your Galco product. It was designed in accordance with the highest engineering standards and hand made using traditional leather craft practices that have become Galco hallmarks over five decades. In the unlikely event a repair is necessary to an unaltered Galco product, simply contact our Customer Service department at 800-874-2526 or customerservice@galcofirearm.com. We will issue you a Return Authorization (RA) number to print on the outside of your shipping container and provide you with detailed shipping instructions.

TERMS OF SALE

Because we have no control over the use of our products, all Galco products are sold as is and "with all faults". The entire risk as to the quality and performance of the product is with the buyer. Should the product prove defective following its purchase, the buyer and not the manufacturer, distributor, or retailer assumes the entire risk of all the necessary servicing or repairs. Under no circumstances shall Galco be liable for incidental or consequential damages, such as loss of use of property, commercial loss and loss of earnings or profits. The implied warranties of merchantability and fitness for a particular purpose and all other warranties, expressed or implied, are excluded from this transaction and shall not apply to the product sold. The determination of the fitness or the suitability of any product for a specific use is the responsibility of the buyer. The illustrations shown herein are typical as to the finish and application. Due to uncontrollable variances in color saturation, the actual product may differ slightly from that shown on our web site. Galco reserves the right to make changes in product built and/or sold by them at any time without incurring any obligation to make same or similar changes on products previously manufactured and/or sold by them. All Galco products are made in the U.S.A. and produced according to rigid specifications. Prices and models are subject to change without notice. Some states do not allow the exclusion or limitation of implied warranties or liability for incidental or consequential damages, so the above limitations and exclusions may not apply to you. Galco designs, features, and model names are the exclusive property of Galco International. Any and all persons including, but not limited to, individuals, firms and/or corporations are forbidden from imitating, copying or reproducing them in any way.