

galcoholsters.com



Galco Customer Service can be reached
Toll Free at 800-874-2526
or by Email at:
customerservice@galcoholsters.com

GALCO[®] HOLSTERS

PRODUCT INFORMATION GUIDE ANKLE HOLSTERS AND ACCESSORIES

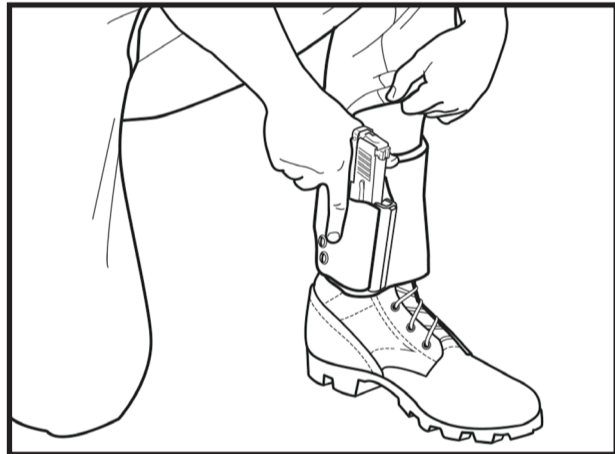

galcoholsters.com
2019 W Quail Avenue Phoenix, AZ 85027

SAFETY SYMBOL DEFINITIONS

! DANGER

Indicates a hazardous situation which, if not avoided, will result in death or serious injury.

! WARNING

Indicates a hazardous situation which, if not avoided, will result in death or serious injury.

! CAUTION

Indicates a hazardous situation which, if not avoided, will result in minor or moderate injury.

NOTICE

Used to address practices unrelated to potential personal injury.



Visit galcousa.com/videos to view related safety videos.

IMPORTANT SAFETY WARNINGS AND INSTRUCTIONS READ PRIOR TO USING GALCO PRODUCTS

! DANGER

Firearms users must understand and obey the Rules of Firearm Safety:

1. **Treat all firearms as if they are always loaded.**
2. **Never point a firearm at anything you aren't willing to shoot.**
3. **Keep your finger off the trigger until you intend to shoot.**
4. **Be sure of your target and what is behind/beyond it.**

Read and understand all owner's manuals, instructions, and guides prepared by the manufacturer of your firearm prior to use. If you have any questions about correct fit, contact Galco Customer Service at **800-874-2526** or customerservice@galcoholsters.com. You may also visit us at galcoholsters.com where you can use our online fitting guide.

! WARNING Carrying a firearm with an ill-fitting or improper holster can result in serious injury or death. The purchase and use of a Galco holster is at the sole and exclusive risk of the user.

READ AND UNDERSTAND THIS ENTIRE GUIDE PRIOR TO USING THIS PRODUCT

Firearms are inherently dangerous. Improper or careless use of a firearm or firearm and holster may result in serious injury or death. It is the user's responsibility to possess a thorough knowledge of, and be properly trained in, all aspects of firearm use, including holster use and safety.

Carry the firearm in the safe condition recommended by its manufacturer. This information will be contained in the product information manual provided by the firearm manufacturer. If you do not have the manual applicable to the firearm, contact the firearm's manufacturer.

It is the user's responsibility to maintain the holster by regularly checking component parts for excessive wear and proper function.

! WARNING Failure to heed these warnings or follow the operating instructions may result in negligent discharge of a firearm, causing serious injury or death.

! WARNING Do not in any way modify, disassemble or remove any part from this holster, except as approved and recommended in Galco's Product Information Guide.

Always place your hand on the firearm when you are performing other physically vigorous activities.

Checking tension units each time the holster is used is required as part of your regular safety inspection. Applying a small amount of clear nail polish to the threads of the tension units, after proper adjustment, will help minimize screw loosening.

! WARNING Tension units are not pre-set at the factory. If a holster has tension units, it is the user's responsibility to ensure they are adjusted to retain the firearm.

! CAUTION Always protect an exposed magazine release from accidental activation.

! WARNING When drawing a firearm or engaging it with the holster, **DO NOT** place your finger on the trigger, in the trigger guard, or near the trigger. Position your finger along the frame of the firearm above the trigger guard. Keep your finger off the trigger until your sights are on target.

! WARNING If the firearm is not properly secured by means of friction from the holsters molding or of the retention device(s), it could become dislodged, causing injury and possibly death to the user and others.

! WARNING A firearm (whether in or out of a holster) may discharge if it falls to the ground or onto another object, causing death or serious injury. Holsters are not designed or intended to prevent firearms from discharging when dropped.

! WARNING A holster is not a replacement for a safe. Firearms should be secured in a locked safe when not in use. Firearms should not be stored in holsters for long periods, even when in a safe. The holster may trap moisture against the firearm and promote corrosion.

! WARNING A significant number of negligent discharges - some resulting in injury or death - occur while holstering a firearm. Most are caused by the user's index finger pressing the trigger. Some are caused because a foreign object becomes entangled or trapped in the trigger guard/holster and presses the trigger. The safest practice is to "look the firearm into the holster". This should be done methodically and without rushing. While holstering, be fully cognizant that:

1. All safeties are engaged.
2. Your index finger is straight along the firearm's frame. **DO NOT** place your finger on the trigger, in the trigger guard, or near the trigger. Keep your finger off the trigger until your sights are on the target.
3. No articles of clothing (shirt tails, jacket drawstrings, etc.) become trapped in the trigger guard, holster, or between the firearm and holster.
4. Your shooting-hand thumb is placed over the hammer or the rear of the slide. This will enable you to feel if the hammer starts to move rearward or the slide begins to come out of battery.
5. You strictly observe Rule of Firearms Safety #2: never point a firearm at anything you aren't willing to shoot. If you do not know how to holster your firearm without breaking this rule, you should seek training before holstering your firearm while the holster is worn.

6. If for any reason you are unable to "look the firearm into the holster" and not muzzle yourself or others, you should remove the holster from your body, then "look the firearm into the holster" (without breaking Rule #2). After the firearm is securely seated in the holster, attach the holster to your body/clothing in the manner in which it was designed.

7. If you holster your firearm while the holster is off and in your hand, insure you do **NOT** point the firearm at your support hand. Do not place your support hand (or other body parts) at the bottom of the holster. The holster material is not bullet proof. Neither your support hand, other body parts, nor other people should be muzzled/flagged while holstering.

CARRY CONDITION OF THE FIREARM

! WARNING Some single-action revolvers and some semi-automatic pistols must be carried with the hammer or firing pin resting on an empty chamber.

Carrying any firearm with a live cartridge in the chamber immediately in front of the firing pin may cause a negligent discharge. Information regarding the safe carry condition of your firearm will be contained in the product information manual provided by the firearm's manufacturer. If you are unsure of the safe carry condition(s) of your firearm, contact the firearm's manufacturer.

! WARNING Never holster a firearm in the single-action mode, unless it is a semi-automatic pistol and holster designed and intended for "cocked and locked" or "Condition One" carry. Always ensure that a single-action pistol carried in "Condition One" has the manual safety engaged when carrying in a holster.

! WARNING Do not use customized, modified, worn or broken firearms, or those otherwise outside the original manufacturer's specifications, with a Galco holster.

! WARNING Do not place a loaded firearm in a holster without first testing - with a firearm double-checked and verified to be unloaded - for proper firearm fit.

! CAUTION Do not attempt to cock a holstered firearm as this may damage the firearm, the holster, or both and may contribute to a negligent discharge.

IF ANY DOUBT EXISTS AS TO THE SERVICEABILITY OR SAFETY OF A GALCO PRODUCT, IMMEDIATELY CEASE USING IT!

If you have questions, contact: Galco Customer Service at **800-874-2526** or customerservice@galcoholsters.com

Galco has made every effort to properly label all holsters for the specific firearms they fit. However, firearms manufacturers often make changes to their firearms that affect holster fit.

Galco will not be responsible for such changes, nor for typographical or other human errors that may occur. It is the user's responsibility to ensure proper holster fit with actual firearms.

It is important to understand that all products, including firearms, holsters and slings may eventually "wear out" or become unsuitable for the function for which they were designed. Stress and strain placed on a product will vary according to frequency and conditions of use, and therefore it is difficult to indicate a recommended replacement date for this product.

PRODUCT IDENTIFICATION

Galco products are generally identified with a two-part code stamped into the holster body or label affixed to the item.

An alphabetical or alphanumeric prefix identifies the holster model. For example, the FLETCH model's prefix is FL while the Royal Guard's prefix is RG.

The numerical suffix identifies the particular firearm the holster is intended to fit. For example, the 212 suffix indicates a 5" 1911 while the 224 suffix indicates a Glock 17. The letter "B" or "H" at the end of the code indicates color. B is for black, H for havana brown, while no letter generally indicates tan.

Thus, an FL212 (FL + 212 + no letter) will be a tan FLETCH to fit a 5" 1911, while an RG224B (RG + 224 + B) will be a black Royal Guard for a Glock 17.

Codes containing the letter 'R' in the suffix indicate that the holster accommodates most red dot sights. For example, a Paragon IWB for the Glock 19 w/wo Red Dot Sight would be marked PAR226RB.

Holsters intended for Galco's modular shoulder systems display letters and numbers that correspond to guns. A Miami Classic holster intended for a SIG P320, for example, will simply read 820.

The numerical suffix of holsters intended for right-hand or ambidextrous use will end in an even number. The suffix of holsters intended for left-hand use will end in an odd number.

You may use the search field found at our website, galcoholsters.com, to locate a holster fit. Simply enter the model number on the item (FL224B, for example) in the field. Should you have questions regarding the identification of the firearm intended for your Galco product, you may also contact Galco's customer service department at **800-874-2526** (during business hours) or by email at customerservice@galcoholsters.com.

! WARNING Galco holsters are approved for use with multiple firearms. Care must always be taken to ensure your holster is an appropriate and approved fit for your firearm.

REPAIRS

Great care was taken to select the finest materials available to craft your Galco product. It was designed in accordance with the highest engineering standards and hand made using traditional leather craft practices that have become Galco hallmarks over five decades. In the unlikely event a repair is necessary to an unaltered Galco product, simply contact our Customer Service department at **800-874-2526** or customerservice@galcoholsters.com. We will issue you a Return Authorization (RA) number to print on the outside of your shipping container and provide you with detailed shipping instructions.

THANK YOU FOR YOUR PURCHASE - WE APPRECIATE IT!

When you really feel the need to conceal, ankle holsters from Galco are the way to go. Our ankle holsters not only offer the concealment you need, but are comfortable enough to wear all through out the day and night. All Galco ankle holsters accommodate ankles up to 13" in circumference and feature a wide neoprene ankle-band and Velcro® closure.

ANKLE GLOVE

The Ankle Glove™ holster is constructed from full grain Premium Steerhide™ and features a retention strap with a reinforced thumb break on most models. Additional comfort and breathability is provided by sheepskin padding.

ANKLE GUARD

The Ankle Guard™ holster is made from Premium Center Cut Steerhide™ and hybrid injection-molded polymer. The passive retention device and twin tension units at the trigger guard ensure retention of the firearm (See illustration B).

ANKLE LITE

The Ankle Lite™ is constructed from Premium Center Cut Steerhide and features a retention strap with a reinforced thumb break. Additional comfort and breathability is provided by sheepskin padding.

COP ANKLE BAND

The Cop Ankle Band™ features an elasticized nylon holster pocket with comfortable acrylic fleece padding. The adjustable Velcro retention strap with reinforced thumb break can be positioned to accommodate a variety of firearms (See illustration C).

ANKLE TRAUMA MEDICAL KIT

The ATM-KIT™ offers secure hook-and-loop closure and five neoprene pockets of various widths, each with a retention strap for security (See illustration D). It accommodates user supplied tools and equipment such as tourniquets, strap cutters, knives, multi-tools, bandages, clotting agents or other emergency rescue and first-aid gear. The ATM-KIT fits ankle/boot circumferences up to 16".

ACCESSORIES

BOOT EXTENDER

The Boot Extender™ is compatible with all Galco ankle products. The Boot Extender adds 1-5" in the circumference and the suede shield protects the ankle cuff from boot-lace hooks. Perfect for use with boots and wider ankles.

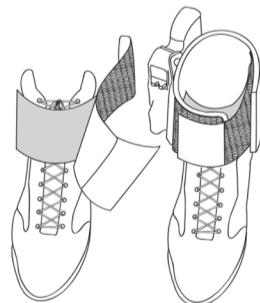

ANKLE CALF STRAP

The Ankle Calf Strap™ counteracts the tendency of gravity to pull the ankle holster down and enables wear at a higher position on the leg. For use with the Ankle Guard, Ankle Glove, and Ankle Lite.

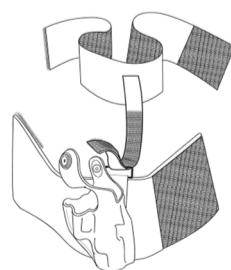

ANKLE SAFE

The Ankle Safe™ is designed to carry accessories for those who need convenience and concealment everyday or in traveling.

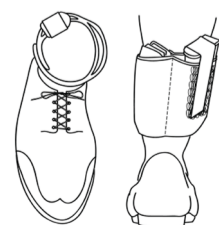

INSPECTIONS + MAINTENANCE, ADDITIONAL USER RESPONSIBILITIES

WARNING It is the user's responsibility to ensure that the Galco product remains serviceable and safe, and able to continue service within its design intent.

NOTICE It is the user's responsibility to inspect the holster before and after each use for signs of excessive wear or loss of retention capability, and appropriate tightness of all hardware.

DO

NOTICE Ensure that all screws are tightened snugly. Applying a small amount of clear nail polish to the threads will minimize screw back out. Ensure that the holster provides secure gun retention in all circumstances.

Clean as needed progressively by wiping with a soft cloth, soft bristle brush, soft damp cloth, soft damp cloth with mild soap to remove stubborn grime. Do not saturate with water and do not run under the tap.

DON'T

WARNING Do not use a loaded firearm in a holster without first testing – with a firearm double-checked and verified to be unloaded – for proper firearm fit.

NOTICE Do not put Galco synthetic or leather products in the washing machine. Do not use any solvents or corrosive chemicals on this product.

Do not use artificial heat to speed up the drying process, i.e. from a hair-dryer, oven, radiator, direct sunlight, etc. Do not leave Galco products on the dashboard of your car in summertime. Do not leave Galco products exposed to direct sunlight or excessive heat for long periods of time.

Do not use Loctite® or threadlock. Outgassing from these adhesive compounds will adversely affect plastic, nylon and rubber parts.

The above care and maintenance instructions cannot substitute for your good common sense. Following our recommended care and maintenance tips will allow you to get the maximum service life from all of your Galco products.

RELEASING A THUMB BREAK STRAP

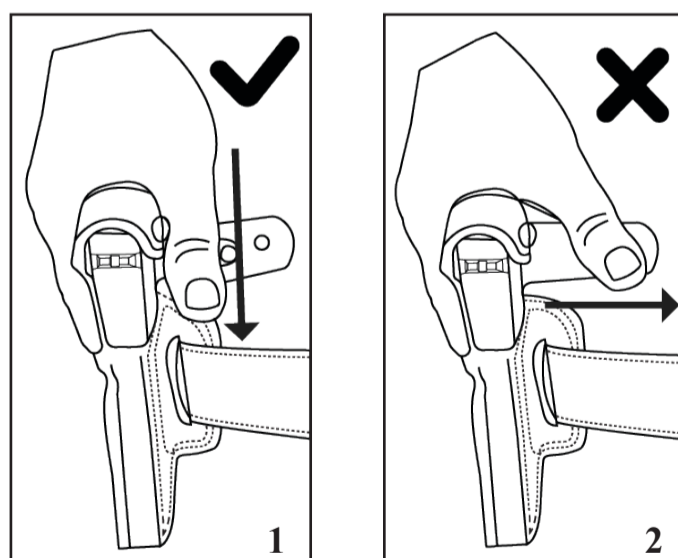

Proper technique for releasing a thumb break retention strap is to drive the thumb briskly straight down through the snap (fig. 1). This fast, single motion will wedge the strap apart and place the thumb in the correct position to achieve a full firing grip prior to the draw.

Do not attempt to release the thumb break by pushing the strap apart with a sideways motion of the thumb (fig. 2). This is not only more difficult, it is slower and clumsier.

HOLSTER FIT / BREAK-IN

Galco's full grain leather holsters are made of the finest materials and are precision molded to specific firearms. It may appear the holster fit is too tight at first, but this is by design. We engineer our holsters to fit tightly knowing the leather fibers will relax to the proper fit with use.

HOLSTER FIT / BREAK-IN (continued)

WARNING UNLOAD YOUR FIREARM (Chamber, magazine, cylinder) before testing holster fit.

If the holster has tension screws: Tension units are not pre-set at the factory. You may need to adjust them in order to holster your handgun for the first time. We recommend that you check your tension screw adjustments before each use. There is no reason to completely remove tension units. Do not use Loctite® on tension units. However, a single drop of clear nail polish applied to your tension screw threads may reduce its unwanted loosening.

If the fit is too tight when holstering your firearm the first time don't force it. If you do force the firearm into the holster, it may be very difficult to remove. Instead, follow these simple steps to break in your new holster using a process called blocking:

1. Place the unloaded firearm in a heavy duty Ziploc® type bag, or cover it in 2-3 layers of plastic kitchen wrap. Do not cover the grip.
3. Once the firearm is completely seated in the holster, twist approximately 1/16" in both directions 6-12 times.
4. Allow the bagged/wrapped firearm to sit in the holster for approximately 15 minutes.
5. Remove the firearm from the holster and remove the bag/wrap from the firearm.
6. Insert the unloaded firearm into the holster, which should now be snug but not loose. If it still too tight, repeat the above steps until the holster is broken in to your satisfaction.
7. If necessary, repeat steps 1-6 with an additional heavy duty Ziploc type bag or additional 2-3 layers of plastic kitchen wrap.

NOTICE If your holster has a retention strap: You may need to stretch the retention strap using your fingers only (no tools, no water, no chemicals, etc.) before you get it to snap.

1. Place the unloaded firearm in the holster.
2. Hold the firearm grip in your strong hand and the retention strap in your support hand.
3. Prepare the strap for stretching by grasping the snap and pulling the strap taut (removing the slack).
4. Twist the strap 90 degrees back and forth in a clockwise and counterclockwise rotation 10-12 times while keeping it taut.
5. Firmly push the firearm away from you while pulling on the strap and continue rotating the strap.
6. Release the tension for a moment and repeat two or three times.
7. Pull the strap over the back of the firearm without releasing tension.
8. While maintaining the strong tension, attempt to snap the retention strap closed.
9. Repeat step 5 as needed.

Following and repeating the above instructions is the only way to an ideal break-in and long service life with proper fit that will last many years.

It is common for the inside of a leather holster to scratch from a single holstering (called etching). A smooth leather lined holster will be even more subject to this normal occurrence. After this initial etching, the holster will custom fit your firearm.

ANKLE HOLSTER PLACEMENT

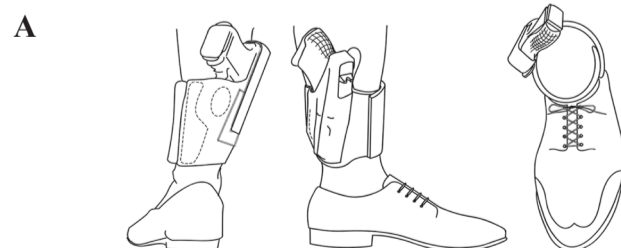

First-time users of ankle holsters often need to do some experimentation to find their most comfortable wearing position. Long-time users have found it most comfortable to wear ankle holsters with the gun slightly back of the anklebone toward the calf. (See illustration A). Your comfort zone is unique to your leg.

ANKLE GUARD PASSIVE RETENTION TRIGGER GUARD

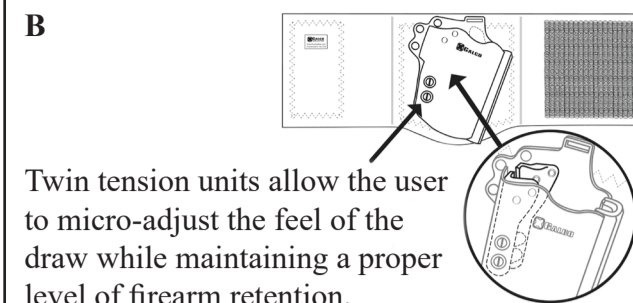

Twin tension units allow the user to micro-adjust the feel of the draw while maintaining a proper level of firearm retention.

COP ANKLE BAND STRAP PLACEMENT

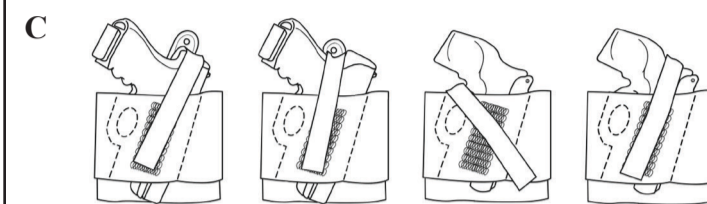

ANKLE TRAUMA MEDICAL KIT

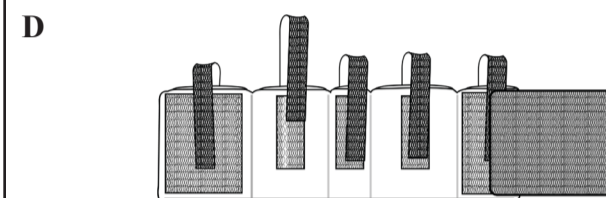

The ATM-KIT does not include tools or supplies only the pocketed ankle cuff, retention straps and optional boot extender panel. Emergency rescue tools and first aid kit supplies are sold separately by other sources.

TERMS OF SALE

Because we have no control over the use of our products, all Galco products are sold as is and "with all faults". The entire risk as to the quality and performance of the product is with the buyer. Should the product prove defective following its purchase, the buyer and not the manufacturer, distributor, or retailer assumes the entire risk of all the necessary servicing or repairs. Under no circumstances shall Galco be liable for incidental or consequential damages, such as loss of use of property, commercial loss and loss of earnings or profits. The implied warranties of merchantability and fitness for a particular purpose and all other warranties, expressed or implied, are excluded from this transaction and shall not apply to the product sold. The determination of the fitness or the suitability of any product for a specific use is the responsibility of the buyer. The illustrations shown herein are typical as to the finish and application. Due to uncontrollable variances in color saturation, the actual product may differ slightly from that shown on our web site. Galco reserves the right to make changes in product built and/or sold by them at any time without incurring any obligation to make same or similar changes on products previously manufactured and/or sold by them. All Galco products are made in the U.S.A. and produced according to rigid specifications. Prices and models are subject to change without notice. Some states do not allow the exclusion or limitation of implied warranties or liability for incidental or consequential damages, so the above limitations and exclusions may not apply to you. Galco designs, features, and model names are the exclusive property of Galco International. Any and all persons including, but not limited to, individuals, firms and/or corporations are forbidden from imitating, copying or reproducing them in any way.