

galcoholsters.com



2019 W Quail Avenue Phoenix, AZ 85027

customer service@galcoholsters.com  
or by Email at:  
Toll Free at 800-874-2526  
Galco Customer Service can be reached

**DEMAND THE BEST!**

## IMPORTANT SAFETY WARNINGS AND INSTRUCTIONS READ PRIOR TO USING GALCO PRODUCTS

### **⚠ DANGER**

**Firearms users must understand and obey the Rules of Firearm Safety:**

1. Treat all firearms as if they are always loaded.
2. Never point a firearm at anything you aren't willing to shoot.
3. Keep your finger off the trigger until you intend to shoot.
4. Be sure of your target and what is behind/beyond it.

**⚠ WARNING** Failure to heed these warnings or follow the operating instructions may result in negligent discharge of a firearm, causing serious injury or death.

Read and understand all owner's manuals, instructions, and guides prepared by the manufacturer of your firearm prior to use.

**⚠ WARNING** Before use, be sure the holster selected is designed and intended to carry your particular firearm.

If you have any questions about correct fit, contact Galco Customer Service at **800-874-2526** or [customerservice@galcoholsters.com](mailto:customerservice@galcoholsters.com). You may also visit us at [galcoholsters.com](http://galcoholsters.com) where you can use our online fitting guide.

**⚠ WARNING** Carrying a firearm with an ill-fitting or improper holster can result in serious injury or death. The purchase and use of a Galco holster is at the sole and exclusive risk of the user.

### READ AND UNDERSTAND THIS ENTIRE GUIDE PRIOR TO USING THIS PRODUCT

Firearms are inherently dangerous. Improper or careless use of a firearm or firearm and holster may result in serious injury or death. It is the user's responsibility to possess a thorough knowledge of, and be properly trained in, all aspects of firearm use, including holster use and safety.

Carry the firearm in the safe condition recommended by its manufacturer. This information will be contained in the product information manual provided by the firearm manufacturer. If you do not have the manual applicable to the firearm, contact the firearm's manufacturer.

It is the user's responsibility to maintain the holster by regularly checking component parts for excessive wear and proper function.

**⚠ WARNING** If the firearm is not properly secured by means of friction from the holsters molding or of the retention device(s), it could become dislodged, causing injury and possibly death to the user and others.

**⚠ WARNING** Never holster a firearm in the single-action mode, unless it is a semi-automatic pistol and holster designed and intended for "cocked and locked" or "Condition One" carry. Always ensure that a single-action pistol carried in "Condition One" has the manual safety engaged when carrying in a holster.

**⚠ WARNING** Always ensure that a single-action pistol carried in "Condition One" had the manual safety engaged when carrying in a holster.

**⚠ CAUTION** Do not attempt to cock a holstered firearm as this may damage the firearm, the holster, or both and may contribute to a negligent discharge.

**⚠ CAUTION** Always protect an exposed magazine release from accidental activation.

**⚠ WARNING** When drawing a firearm or engaging it with the holster, DO NOT place your finger on the trigger, in the trigger guard, or near the trigger. Position your finger along the frame of the firearm above the trigger guard. Keep your finger off the trigger until your sights are on target.

**⚠ WARNING** A significant number of negligent discharges - some resulting in injury or death - occur while holstering a firearm. Most are caused by the user's index finger pressing the trigger. Some are caused because a foreign object become entangled or trapped in the trigger guard/holster and presses the trigger. The safest practice is to "look the firearm into the holster." This should be done methodically and without rushing. While holstering, be fully cognizant that:

1. All safeties are engaged.
2. Your index finger is straight along the firearm's frame. Do NOT place your finger on the trigger, in the trigger guard, or near the trigger. Keep your finger off the trigger until your sights are on target.
3. No articles of clothing (shirt tails, jacket drawstrings, etc.) become trapped in the trigger guard, holster, or between the firearm and holster.
4. Your shooting-hand thumb is placed over the hammer or the rear of the slide. This will enable you to feel if the hammer starts to move rearward or the slide begins to come out of battery.

5. You strictly observe Rule of Firearms Safety #2: never let the muzzle cover anything you're not willing to destroy. If you do not know how to holster your firearm without breaking this rule, you should seek training before holstering your firearm while the holster is worn.

6. If for any reason you are unable to "look the firearm into the holster" and not muzzle yourself or others, you should remove the holster from your body, then "look the firearm into the holster" (without breaking Rule #2). After the firearm is securely seated in the holster, attach the holster to your body/clothing in the manner in which it was designed.

7. If you holster your firearm while the holster is off and in your hand, insure you do NOT point the firearm at your support hand. Do not place your support hand (or other body parts) at the bottom of the holster. The holster material is not bullet proof. Neither your support hand, other body parts, nor other people should be muzzled/flagged while holstering.

**⚠ WARNING** A firearm (whether in or out of a holster) may discharge if it falls to the ground or onto another object, causing death or serious injury. Holsters are not designed or intended to prevent firearms from discharging when dropped.

Always place your hand on the firearm when you are performing other physically vigorous activities.

Checking tension units each time the holster is used is required as part of your regular safety inspection. Applying a small amount of clear nail polish to the threads of the tension units, after proper adjustment, will help minimize screw loosening.

**⚠ WARNING** Do not use customized, modified, worn or broken firearms, or those otherwise outside the original manufacturer's specifications, with a Galco holster.

**⚠ WARNING** Do not in any way modify, disassemble or remove any part from this holster, except as approved and recommended in Galco's Product Information Guide.

**⚠ WARNING** Tension units are not pre-set at the factory. If a holster has tension units, it is the user's responsibility to ensure they are adjusted to retain the firearm.

**⚠ WARNING** A holster is not a replacement for a safe. Firearms should be secured in a locked safe when not in use. Firearms should not be stored in holsters for long periods, even when in a safe. The holster may trap moisture against the firearm and promote corrosion.

### CARRY CONDITION OF THE FIREARM

**⚠ WARNING** Some single-action revolvers and some semi-automatic pistols must be carried with the hammer or firing pin resting on an empty chamber.

Carrying any firearm with a live cartridge in the chamber immediately in front of the firing pin may cause a negligent discharge. Information regarding the safe carry condition of your firearm will be contained in the product information manual provided by the firearm's manufacturer. If you are unsure of the safe carry condition(s) of your firearm, contact the firearm's manufacturer.

**⚠ WARNING** Do not place a loaded firearm in a holster without first testing - with a firearm double-checked and verified to be unloaded - for proper firearm fit.

### PRODUCT IDENTIFICATION

Galco products are generally identified with a two - part code stamped into the holster body or label affixed to the item.

An alphabetical or alphanumeric prefix identifies the holster model. For example, the FLETCH model's prefix is FL while the Royal Guard's prefix is RG.

The numerical suffix identifies the particular firearm the holster is intended to fit. For example, the 212 suffix indicates a 5" 1911 while the 224 suffix indicates a Glock 17. The letter "B" or "H" at the end of the code indicates color. B is for black, H for Havana brown, while no letter generally indicates tan.

Thus, an FL212 (FL + 212 + no letter) will be a tan FLETCH to fit a 5" 1911, while an RG224B (RG + 224 + B) will be a black Royal Guard for a Glock 17.

Codes containing the letter 'R' in the suffix indicate that the holster accommodates most red dot sights. For example, a Paragon 2.0 IWB for the Glock 19 w/wo Red Dot Sight would be marked PA2-226RB.

Holsters intended for Galco's modular shoulder systems display letters and numbers that correspond to guns. A Miami Classic holster intended for a SIG P320, for example, will simply read 820.

The numerical suffix of holsters intended for right-hand or ambidextrous use will end in an even number. The suffix of holsters intended for left-hand use will end in an odd number.

You may use the search field found at our website, [galcoholsters.com](http://galcoholsters.com), to locate a holster fit. Simply enter the model number on the item (FL224B, for example) in the field. Should you have questions regarding the identification of the firearm intended for your Galco product, you may also contact Galco's customer service department at 800-874-2526 (during business hours) or by email at [customerservice@galcoholsters.com](mailto:customerservice@galcoholsters.com).

## IF ANY DOUBT EXISTS AS TO THE SERVICEABILITY OR SAFETY OF A GALCO PRODUCT, IMMEDIATELY CEASE USING IT!

If you have questions, contact: Galco Customer Service at 800-874-2526 or [customerservice@galcoholsters.com](mailto:customerservice@galcoholsters.com)

Galco has made every effort to properly label all holsters for the specific firearms they fit. However, firearms manufacturers often make changes to their firearms that affect holster fit.

Galco will not be responsible for such changes, nor for typographical or other human errors that may occur. It is the user's responsibility to ensure proper holster fit with actual firearms.

It is important to understand that all products, including firearms, holsters and slings may eventually "wear out" or become unsuitable for the function for which they were designed. Stress and strain placed on a product will vary according to frequency and conditions of use, and therefore it is difficult to indicate a recommended replacement date for this product.

**⚠ WARNING** Galco holsters are approved for use with multiple firearms. Care must always be taken to ensure your holster is an appropriate and approved fit for your firearm.

### REPAIRS

Great care was taken to select the finest materials available to craft your Galco product. It was designed in accordance with the highest engineering standards and hand made using traditional leather craft practices that have become Galco hallmarks over five decades. In the unlikely event a repair is necessary to an unaltered Galco product, simply contact our Customer Service department at **800-874-2526** or [customerservice@galcoholsters.com](mailto:customerservice@galcoholsters.com). We will issue you a Return Authorization (RA) number to print on the outside of your shipping container and provide you with detailed shipping instructions.

### TERMS OF SALE

Because we have no control over the use of our products, all Galco products are sold as is and "with all faults". The entire risk as to the quality and performance of the product is with the buyer. Should the product prove defective following its purchase, the buyer and not the manufacturer, distributor, or retailer assumes the entire risk of all the necessary servicing or repairs. Under no circumstances shall Galco be liable for incidental or consequential damages, such as loss of use of property, commercial loss and loss of earnings or profits. The implied warranties of merchantability and fitness for a particular purpose and all other warranties, expressed or implied, are excluded from this transaction and shall not apply to the product sold. The determination of the fitness or the suitability of any product for a specific use is the responsibility of the buyer. The illustrations shown herein are typical as to the finish and application. Due to uncontrollable variances in color saturation, the actual product may differ slightly from that shown on our web site. Galco reserves the right to make changes in product built and/or sold by them at any time without incurring any obligation to make same or similar changes on products previously manufactured and/or sold by them. All Galco products are made in the U.S.A. and produced according to rigid specifications. Prices and models are subject to change without notice. Some states do not allow the exclusion or limitation of implied warranties or liability for incidental or consequential damages, so the above limitations and exclusions may not apply to you. Galco designs, features, and model names are the exclusive property of Galco International. Any and all persons including, but not limited to, individuals, firms and/or corporations are forbidden from imitating, copying or reproducing them in any way.

## SAFETY SYMBOL DEFINITIONS

### **⚠ DANGER**

Indicates a hazardous situation which, if not avoided, will result in death or serious injury.

### **⚠ WARNING**

Indicates a hazardous situation which, if not avoided, will result in death or serious injury.

### **⚠ CAUTION**

Indicates a hazardous situation which, if not avoided, will result in minor or moderate injury.

### **NOTICE**

Used to address practices unrelated to potential personal injury.



Visit [galcoholsters.com/videos](http://galcoholsters.com/videos) to view Related safety videos.

## THANK YOU FOR YOUR PURCHASE! FASTRAX PAC

Galco's FasTrax PAC™ is designed to blend with modern casual clothing styles while discreetly carrying a compact or subcompact defensive handgun ready for quick action. This hidden open carry holster allows you to conceal a handgun in plain sight with style! The innovative pivoting holster component works in concert with an activation cord to create a simple, fast draw method that eliminates the need to dig inside the body of the pack to retrieve the handgun. The firearm may be accessed in a traditional manner as well.

The FasTrax PAC is available in two sizes, with the "S" suffix denoting units for subcompact autos and small-frame revolvers, and the "C" suffix indicating units for handguns up to compact autos. The holster component is the same for both sizes, with the difference being the size of the pack interior. The subcompact measures 11 1/2" wide x 5 1/4" high, while the compact measures 11 1/2" wide x 6 1/8" high. The compact will accommodate most red dot sights, while the subcompact will not.

The stretchable elasticized waist strap combines with Galco's Comfort Cloth™ backing for the utmost comfort, even in hot weather. The user-adjustable holster component can be configured for dozens of different popular handguns. The FasTrax PAC tops the list for convenient, comfortable concealed carry in an increasingly casually-dressed world.

### INSPECTIONS + MAINTENANCE, ADDITIONAL USER RESPONSIBILITIES

**WARNING** It is the user's responsibility to ensure that the Galco product remains serviceable and safe, and able to continue service within its design intent.

**NOTICE** It is the user's responsibility to inspect the holster before and after each use for signs of excessive wear or loss of retention capability, and appropriate tightness of all hardware.

### DO

**NOTICE** Ensure that all screws are tightened snugly. Applying a small amount of clear nail polish to the threads will minimize screw back out. Ensure that the holster provides secure gun retention in all circumstances.

Clean as needed progressively by wiping with a soft cloth, soft bristle brush, soft damp cloth, soft damp cloth with mild soap to remove stubborn grime. Do not saturate with water and do not run under the tap.

Galco Leather Lotion is also an excellent solution for cleaning and maintaining full-grain leather holsters.

### DON'T

**WARNING** Do not use a loaded firearm in a holster without first testing – with a firearm double-checked and verified to be unloaded – for proper firearm fit.

**NOTICE** Do not put Galco synthetic or leather products in the washing machine. Do not use any solvents of corrosive chemicals on this product.

Do not use artificial heat to speed up the drying process, i.e. from a hair-dryer, oven, radiator, direct sunlight, etc. Do not leave Galco products on the dashboard of your car in summertime. Do not leave Galco products exposed to direct sunlight or excessive heat for long periods of time.

Do not use LocTite® or threadlock. Outgassing from these adhesive compounds will adversely affect plastic, nylon and rubber parts.

The above care and maintenance instructions cannot substitute for your good common sense. Following our recommended care and maintenance tips will allow you to get the maximum service life from all of your Galco products.

**WARNING** Care must always be taken to ensure your holster is an appropriate and approved fit for your firearm and adjusted according to the above guidelines. Never carry a firearm in any holster not specifically recommended by Galco for that firearm. For a complete list of gun fits, visit galcousa.com

## HOLSTER ADJUSTMENT FOR YOUR FIREARM

**WARNING** UNLOAD YOUR FIREARM (magazine, chamber, cylinder) before testing holster fit.

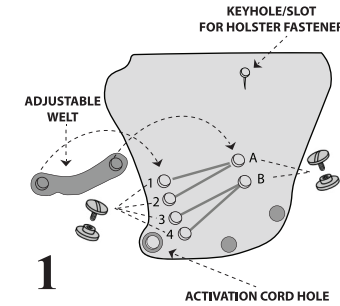

The holster component need not be removed to adjust gun fit, but if you wish to remove it please refer to the information at **illustration 2**.

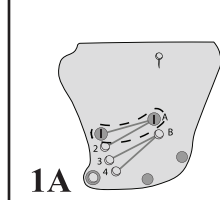

**CAUTION** Ensure that the adjustable welt is sandwiched between the walls of the holster, secured by both screws and positioned to cradle the trigger guard. A welt turned convex will impede holster fit.

### PAC SIZE & WELT SETTINGS FOR SPECIFIC HANDGUNS

SUBCOMPACT /COMPACT PAC	WELT SETTING	HANDGUN
SC/C	2A	1911 3"
C	2A	1911 3.5"-4"
SC/C	2A	Bersa BP9
C	2A	Bersa Thunder .380
SC/C	4B	Charter Arms Bulldog
SC/C	4B	Charter Arms Undercover
SC/C	4B	Colt Cobra
SC/C	4B	Colt Detective Special
SC/C	1A	Colt Mustang
SC/C	1A	Diamondback DB380/DB9
C	3B	Glock 19/23/29/30
SC/C	3B	Glock 26/27/33
SC/C	2A	Glock 42/43/43X/48
C	3B	Hi-Point C9
C	3B	HK P2000SK/VP9SK
SC/C	3B	Honor Defense Honor Guard
SC/C	2A	Kahr 45
C	2A	Kahr K9/40/Similar
SC/C	1A	Keltic P3AT
SC/C	1A	Kimber Micro 9
C	3B	Kimber R7
SC/C	2A	Kimber Solo
SC/C	3B	Mossberg MC1SC
SC/C	1A	Remington RM380
SC/C	2A	Ruger LC9
SC/C	1A	Ruger LCP I/II
SC/C	1A	Ruger LCP Max
SC/C	4B	Ruger LCR/SP101
SC/C	3B	Ruger Max 9
SC/C	3B	Ruger Security-9 Compact/Similar
SC/C	3B	Savage Stance
C	3B	SIG-Sauer P229/P239
C	1A	SIG-Sauer P230/P232/Similar
C	4B	SIG-Sauer P320C/P320SC/Similar
SC/C	2A	SIG-Sauer P365/P365 XL/Similar
SC/C	1A	SIG-Sauer P938
SC/C	2A	Springfield Hellcat
C	2A	Springfield Hellcat Pro
C	3B	Springfield XDS
C	3B	Springfield XD-S 3.3"
SC/C	3B	S&W J-Frame
SC/C	4B	S&W J-Frame Scandium
C	3B	S&W M&P Compact
C	3B	S&W Shield 2.0
SC/C	3B	S&W Shield 9/40/45
SC/C	2A	S&W Shield EZ
SC/C	3B	S&W Shield Plus
SC/C	4B	Taurus 85/605/Similar
C	3B	Taurus G2C/G2S/G3C
SC/C	2A	Taurus GX4
C	3B	Taurus P111/PT140/PT145
C	3B	Taurus Millennium Pro
SC/C	1A	Walther PPK/Similar
C	3B	Walther PPS/Similar

## WELT ADJUSTMENTS

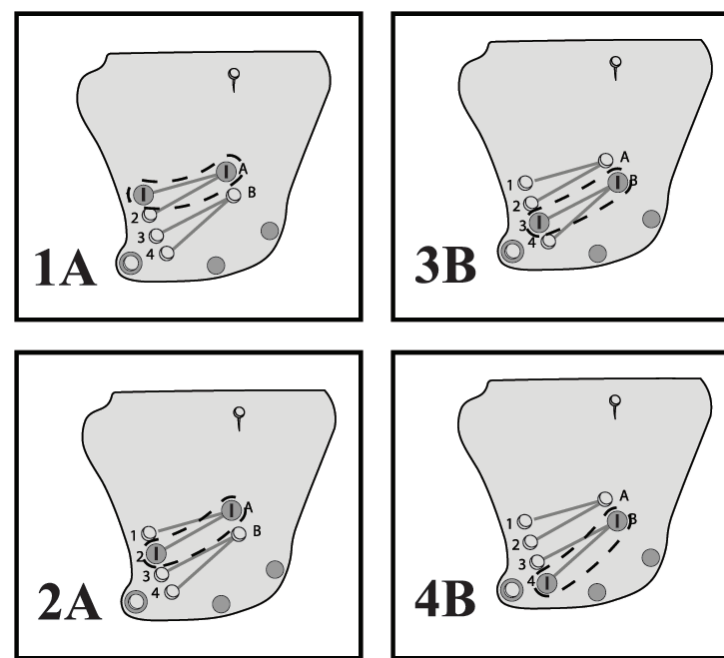

**WARNING** After removing the holster component for any reason, ensure that the holster component fasteners are seated securely within the keyholes/slots on the holster component. Reattach each fastener one at a time by inserting the fastener through the hole of the keyhole/slot.

**WARNING** The trigger should not be touched and your finger should not enter the trigger guard until your sights are on the target.

## DRAWING FROM FASTRAX PAC

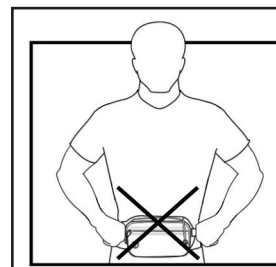

**WARNING** In order to avoid muzzling body parts DO NOT wear the FasTrax PAC centered on your abdomen. When wearing the FasTrax Pac ensure that it is off the centerline of the body, either to the left or the right.



Simultaneously grasp the activation cord with your support hand and the top zipper pull with your primary hand. See **illustration 6**.

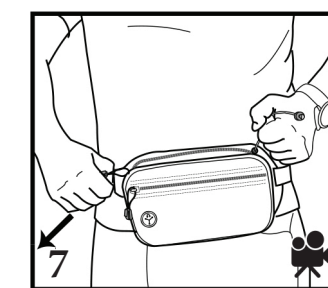

Completely unzip the holster compartment. See **illustration 7**.

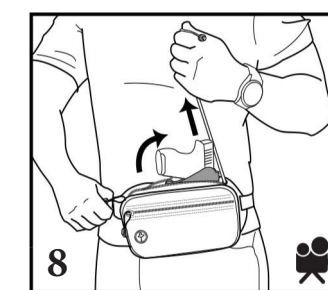

Pull the activation cord up and towards the centerline (solar plexus area) of your body. This will rotate the holster almost 90 degrees, with the butt of the firearm coming out of the holster compartment. See **illustration 8**.

**WARNING** Do not pull the activation cord to the front or the side, as this can cause the muzzle to cross the support hand during the draw. The smoothest, safest draw method is to pull the activation cord up and towards the centerline of the body.

## DRAWING FROM FASTRAX PAC CONTINUED

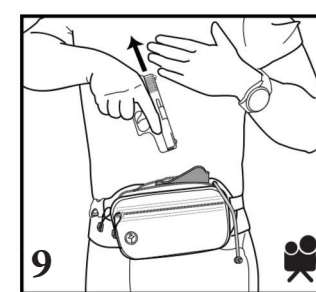

Grasp the butt of the firearm in a firing grip while keeping your trigger finger straight. Pull the firearm up and out of the holster, while simultaneously releasing the activation cord from the support hand. Allow the activation cord to fall away from the support hand. Your

support hand should remain in position on your chest. See **illustration 9**. Once the firearm is pointed towards the target and before extending your arms, grip the firearm with both hands using a proper shooting grip as taught by an accredited firearms safety and training course.

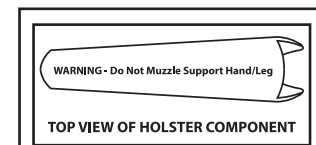

**WARNING** Do Not Muzzle Support Hand/Leg

**WARNING** While easing the firearm into the holster, ensure that you do not allow muzzle to cross your support arm, hand or leg.

## HOLSTERING

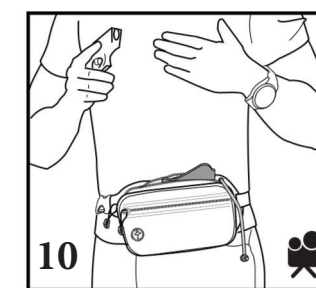

1. Return your support hand to the center of your chest while visually confirming that the holster is not obstructed and in the vertical position. See **illustration 10**.

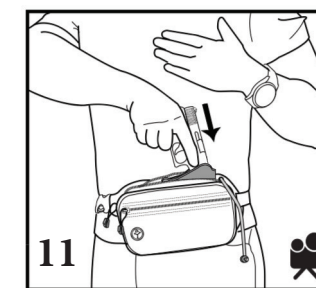

2. With your finger well clear of the trigger and along firearm's frame, gently ease the firearm into the holster. See **illustration 11**.

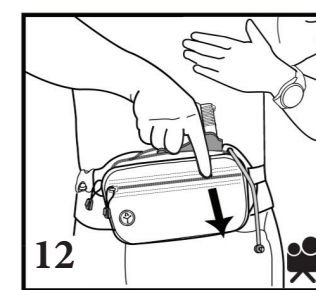

3. Slowly seat the firearm completely in the holster. See **illustration 12**.

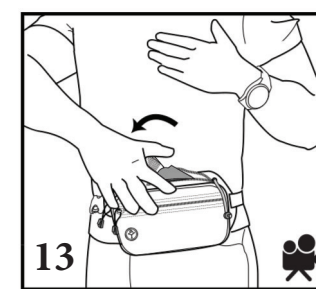

4. Pivot the firearm and holster component so it is completely enclosed in the holster compartment. See **illustration 13**.

## LEFT HAND CONVERSION

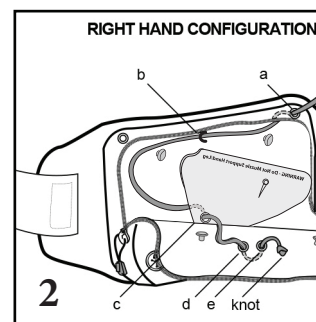

The FasTrax PAC comes configured for right hand use. To convert to left hand use, remove and reverse the holster by shifting the holster component until the post of the fastener is within the hole of the keyhole slot. Release the holster fasteners one at a time. See **illustration 2**.

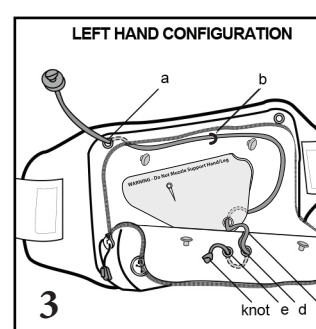

Untie the knot at the end of the activation cord and pass the cord through the indicated holes in the order shown. Tie a secure knot at the end of the activation cord. See **illustration 3**.

## LEFT HAND CONVERSION CONTINUED

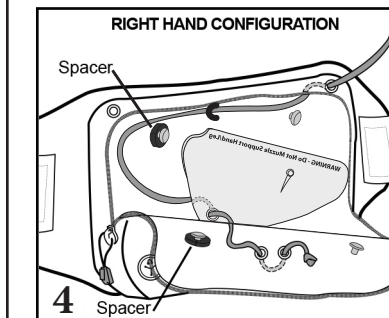

When converting from right hand to left hand operation, ensure that the holster fastener spacers are moved to the opposing holster fasteners. The spacers help ensure that the firearm does not hang up during the draw. See **illustration 4 & 5**.

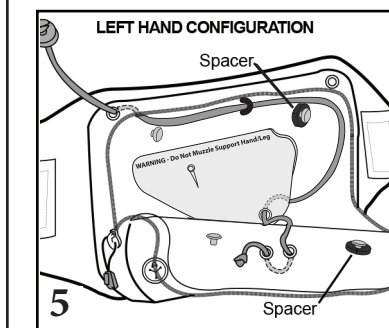

## PRO TIP!

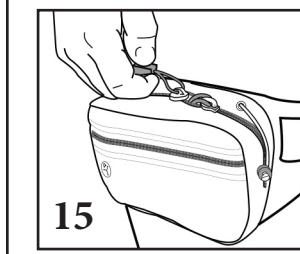

There are two zipper pulls on the firearm compartment, one for right hand and one for left hand use. During use, ensure that the unused zipper pull is tucked into the holster compartment while the active zipper pull remains free to grasp. See **illustration 15**.



The exterior accessory pocket features a convenient pass-through port for head-phones or other cables.

## FASTRAX PAC WAIST STRAP EXTENDER

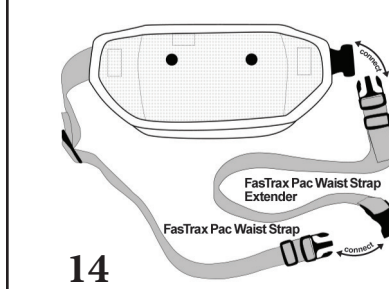

The optional Waist Strap Extender accessory adds 6"-24" to strap length and attaches with additional Nexus buckles. See **illustration 2**.

## The FasTrax PAC is available in:



Gray/Black  
Nylon/Neoprene



MultiCam Black  
Nylon Packcloth

## The FasTrax PAC Elite is available in:



Black  
Full-Grain Leather