

galcousa.com



Galco Customer Service can be reached  
Toll Free at 800-874-2526  
or by Email at:  
customerservice@galcofirearm.com



## PRODUCT INFORMATION GUIDE SLC STRAP & BUNGEE SLING



**galcousa.com**  
2019 W Quail Avenue Phoenix, AZ 85027

## SAFETY SYMBOL DEFINITIONS

### **⚠ DANGER**

Indicates a hazardous situation which, if not avoided, will result in death or serious injury.

### **⚠ WARNING**

Indicates a hazardous situation which, if not avoided, will result in death or serious injury.

### **⚠ CAUTION**

Indicates a hazardous situation which, if not avoided, will result in minor or moderate injury.

### **NOTICE**

Used to address practices unrelated to potential personal injury.



Visit [galcousa.com/videos](http://galcousa.com/videos) to view related safety videos.

## IMPORTANT SAFETY WARNINGS AND INSTRUCTIONS READ PRIOR TO USING GALCO PRODUCTS

### **⚠ DANGER**

Firearms users must understand and obey the Rules of Firearm Safety:

1. Treat all firearms as if they are always loaded.
2. Never point a firearm at anything you aren't willing to shoot.
3. Keep your finger off the trigger until you intend to shoot.
4. Be sure of your target and what is behind/beyond it.

**⚠ WARNING** Failure to heed these warnings or follow the operating instructions may result in negligent discharge of a firearm, causing serious injury or death.

Read and understand all owner's manuals, instructions, and guides prepared by the manufacturer of your firearm prior to use.

If you have any questions about correct fit, contact Galco Customer Service at **800-874-2526** or [customerservice@galcofirearm.com](mailto:customerservice@galcofirearm.com). You may also visit us at [galcousa.com](http://galcousa.com) where you can use our online fitting guide.

**⚠ WARNING** Carrying a firearm with an ill-fitting or improper sling can result in serious injury or death. The purchase and use of a Galco sling is at the sole and exclusive risk of the user.

### READ AND UNDERSTAND THIS ENTIRE GUIDE PRIOR TO USING THIS PRODUCT

Firearms are inherently dangerous. Improper or careless use of a firearm or firearm and sling may result in serious injury or death. It is the user's responsibility to possess a thorough knowledge of, and be properly trained in, all aspects of firearm use, including sling use and safety.

Carry the firearm in the safe condition recommended by its manufacturer. This information will be contained in the product information manual provided by the firearm manufacturer. If you do not have the manual applicable to the firearm, contact the firearm's manufacturer.

It is the user's responsibility to maintain the sling by regularly checking component parts for excessive wear and proper function.

**⚠ CAUTION** Always protect an exposed magazine release from accidental activation.

**⚠ WARNING** When slinging your firearm, DO NOT place your finger on the trigger, in the trigger guard, or near the trigger. Position your finger along the frame of the firearm above the trigger guard. Keep your finger off the trigger until your sights are on target. 

Always place your hand on the firearm when you are running or performing other physically vigorous activities.

It is the user's responsibility to maintain the sling by regularly checking component parts for excessive wear and proper function. This includes, but is not limited to, buckles, straps and other hardware.

**⚠ WARNING** Do not use customized, modified, worn or broken firearms, or those otherwise outside the original manufacturer's specifications, with a Galco sling.

**⚠ WARNING** Do not in any way modify, disassemble or remove any part from this sling, except as approved and recommended in Galco's Product Information Guide.

## INSPECTIONS + MAINTENANCE, ADDITIONAL USER RESPONSIBILITIES

**⚠ WARNING** It is the user's responsibility to ensure that the item remains serviceable and safe, and able to continue service within its design intent.

**NOTICE** It is the user's responsibility to inspect the sling before and after each use for signs of excessive wear or loss of retention capability, and appropriate tightness of all hardware.

**NOTICE** Do not expose your sling to extreme heat, such as the interior of a car in summer, or leave it otherwise exposed to the elements.

**⚠ WARNING** When the sling is in use, ensure that the weapon's safety/selector lever remains clear of the web gear, ammo carriers, or other equipment that may move the safety/selector to the "fire" position and/or engage the trigger.

## DO

**NOTICE** Ensure that all screws are tightened snugly. Applying a small amount of clear nail polish to the threads will minimize screw back out.

Ensure that the sling provides secure gun retention in all circumstances.

Clean as needed by hand using a soft bristle brush. If additional cleaning is needed, wash by hand with a mild soap and water, allow to air dry naturally.

After washing, apply a very light coat of WD40 to all metal components (hardware).

## DON'T

**⚠ WARNING** Do not use a loaded firearm with a sling without first testing – with a firearm double-checked and verified to be unloaded – for proper firearm fit.

**NOTICE** Do not put Galco synthetic material products in the washing machine.

Do not use artificial heat to speed up the drying process, i.e. from a hair-dryer, oven, radiator, direct sunlight, etc.

Do not use any solvents of corrosive chemicals on this product.

Do not leave Galco products on the dashboard of your car in summertime.

Do not leave Galco products exposed to direct sunlight or excessive heat for long periods of time.

Do not use LocTite® or threadlock. Outgassing from these adhesive compounds will adversely affect plastic, nylon and rubber parts.

The above care and maintenance instructions cannot substitute for your good common sense. Following our recommended care and maintenance tips will allow you to get the maximum service life from all of your Galco products.

## CARRY CONDITION OF THE FIREARM

Carrying any firearm with a live cartridge in the chamber immediately in front of the firing pin may cause a negligent discharge. Information regarding the safe carry condition of your firearm will be contained in the product information manual provided by the firearm's manufacturer. If you are unsure of the safe carry condition(s) of your firearm, contact the firearm's manufacturer.

## IF ANY DOUBT EXISTS AS TO THE SERVICEABILITY OR SAFETY OF A GALCO PRODUCT, IMMEDIATELY CEASE USING IT!

If you have questions, contact: Galco  
Customer Service at **800-874-2526** or  
[customerservice@galcofirearm.com](mailto:customerservice@galcofirearm.com)

Galco has made every effort to properly label all holsters for the specific firearms they fit. However, firearms manufacturers often make changes to their firearms that affect holster fit.

Galco will not be responsible for such changes, nor for typographical or other human errors that may occur. It is the user's responsibility to ensure proper holster fit with actual firearms.

It is important to understand that all products, including firearms, holsters and slings may eventually "wear out" or become unsuitable for the function for which they were designed. Stress and strain placed on a product will vary according to frequency and conditions of use, and therefore it is difficult to indicate a recommended replacement date for this product.

## PRODUCT IDENTIFICATION

Galco products are generally identified with a two-part code stamped into the holster body or label affixed to the item.

An alphabetical or alphanumeric prefix identifies the holster model. For example, the FLETCH model's prefix is FL while the Royal Guard's prefix is RG.

The numerical suffix identifies the particular firearm the holster is intended to fit. For example, the 212 suffix indicates a 5" 1911 while the 224 suffix indicates a Glock 17. The letter "B" or "H" at the end of the code indicates color. B is for black, H for havana brown, while no letter generally indicates tan.

Thus, an FL212 (FL + 212 + no letter) will be a tan FLETCH to fit a 5" 1911, while an RG224B (RG + 224 + B) will be a black Royal Guard for a Glock 17.

Holsters intended for Galco's modular shoulder systems display letters and numbers that correspond to guns. A Miami Classic holster intended for a SIG P320, for example, will simply read 820.

The numerical suffix of holsters intended for right-hand or ambidextrous use will end in an even number. The suffix of holsters intended for left-hand use will end in an odd number.

You may use the search field found at our website, [galcousa.com](http://galcousa.com), to locate a holster fit. Simply enter the model number on the item (FL224B, for example) in the field. Should you have questions regarding the identification of the firearm intended for your Galco product, you may also contact Galco's customer service department at **800-874-2526** (during business hours) or by email at [customerservice@galcofirearm.com](mailto:customerservice@galcofirearm.com).

**⚠ WARNING** Galco products are approved for use with multiple firearms. Care must always be taken to ensure your sling is an appropriate and approved fit for your firearm.



**THANK YOU FOR YOUR PURCHASE  
OF A GALCO PRODUCT! WE  
APPRECIATE YOUR BUSINESS.**

**SLC STRAP**

The Simple Lanyard and Carrying (SLC™) Strap offers quick and simple attachment to virtually any rifle fitted with sling swivels, and two carry positions. The first position is a conventional and comfortable two-point carrying position, allowing muzzle-up or muzzle-down rifle carry over the shoulder or across the back. In the second position – for tactical use – the SLC Strap operates much like a single-point sling, positioning the rifle at the front of the body in a safe but easily-accessed muzzle-down position. An HK-style snap hook allows quick and effortless transition between the two carry methods

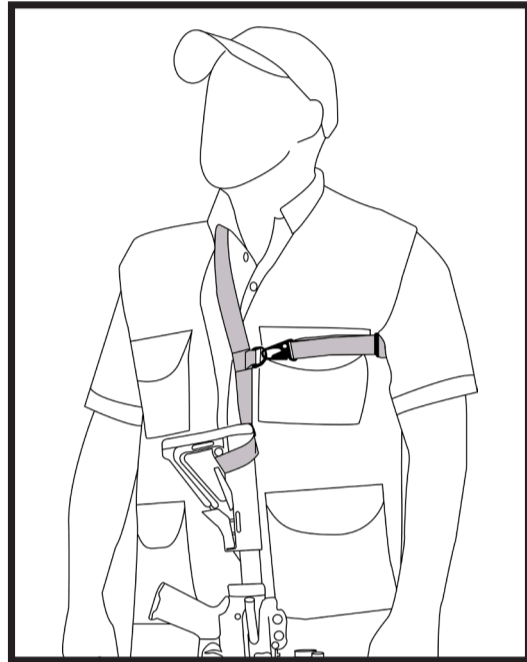

**BUNGEE SLING**

The single-point Bungee Sling attaches to long guns with a nylon loop or an included HK-style snap hook. Constructed of shock-absorbing elasticized synthetic material, the Bungee Sling works perfectly for transitions to the backup handgun, support-side shooting, and muzzle strikes. Adjustable for length and ride height, the Bungee Sling adapts to nearly any shooter, regardless of size or gear worn.

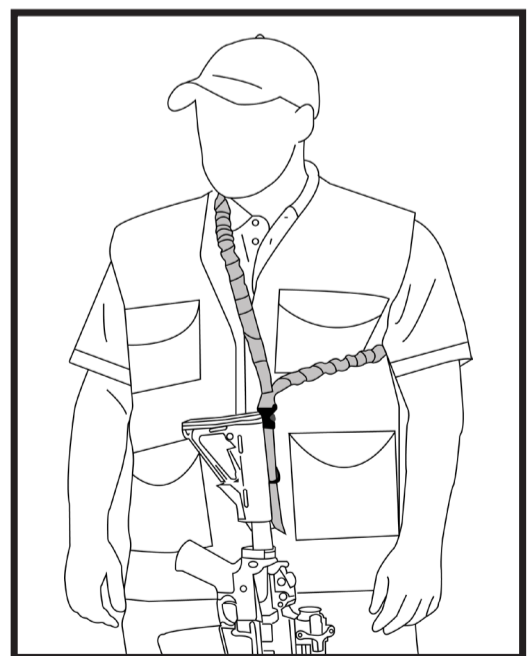

**SLC STRAP INSTALLATION AND USE**

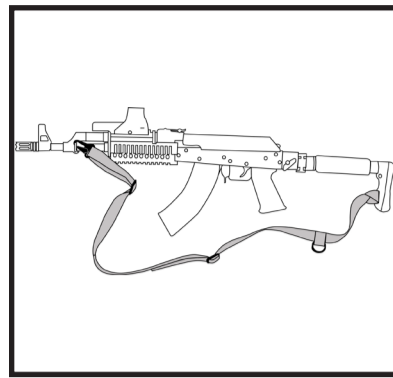

1. Thread the looped end of the SLC Strap through the rifle's rear sling swivel or buttstock slot. Attach the Strap to the forward sling swivel using the provided HK-style snap hook.

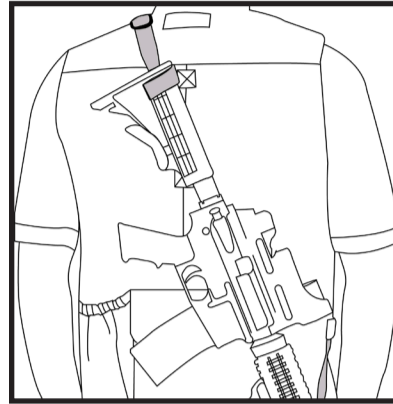

2. This will provide conventional carry over the shoulder or across the back.

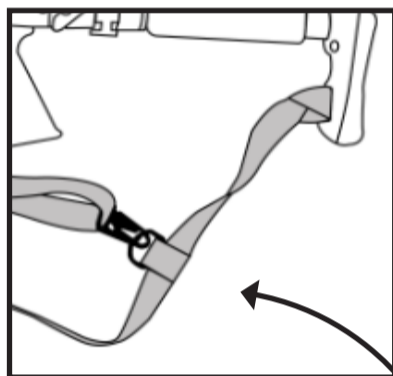

3. Detach the snap hook from the forward sling swivel and attach it to the D-ring found on main sling strap. This can be done with the sling on or off your body.

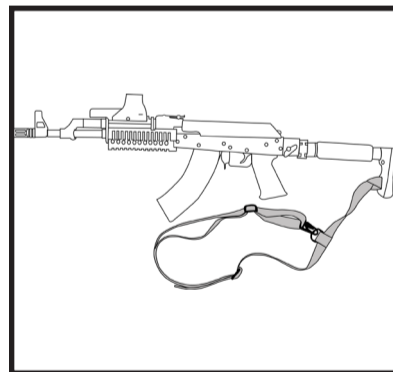
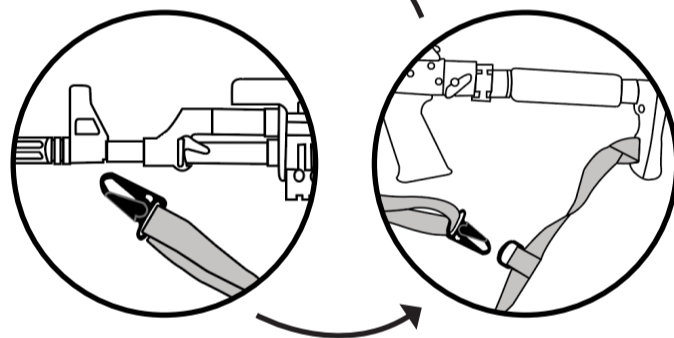

4. This creates a single-point tactical sling configuration.



5. Wear the rifle slung at the front of your body.

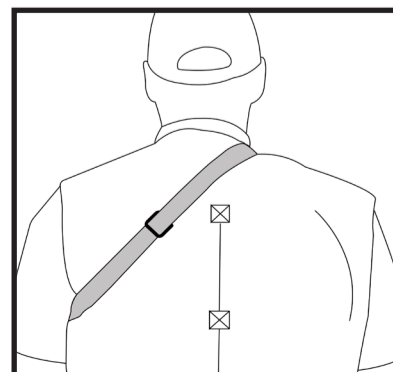

6. The strap should pass diagonally over your shoulder and across your back.

**SLC STRAP INSTALLATION AND USE  
(continued)**



7. Simply lift the rifle to bring it into action.

**BUNGEE SLING INSTALLATION AND USE**

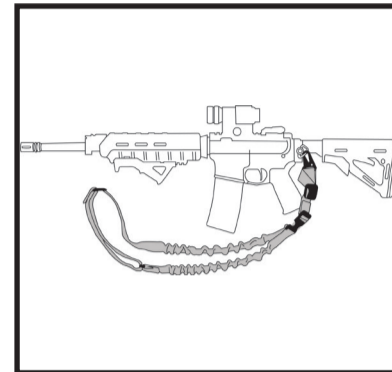

1. Attach the Bungee to the rifle's rear mounting point.

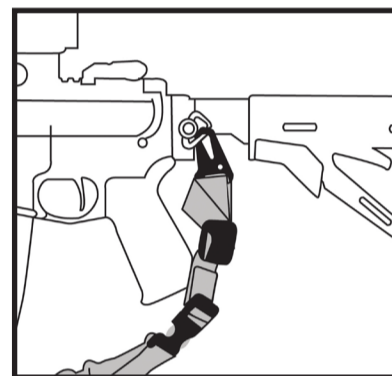

2. This can be done with the provided HK-style snap hook.

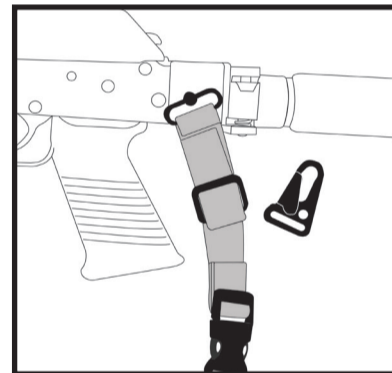

3. Alternately, the hook can be removed by unthreading the strap. Thread the strap directly onto the rifle's rear sling swivel. Lock the strap as shown in **Illustration 7**.



4. Wear the rifle slung at the front of your body.

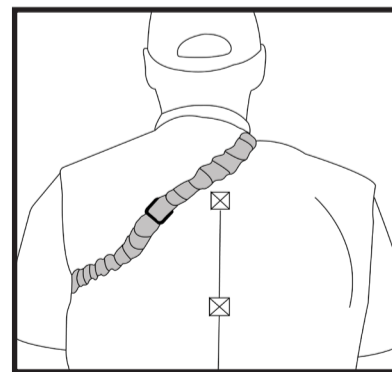

5. The strap should pass diagonally over your shoulder and across your back.

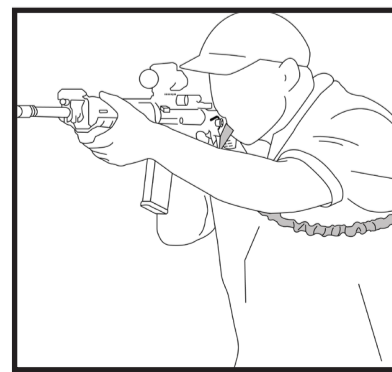

6. Simply lift the rifle to bring it into action.

**7. TRI-GLIDE BUCKLES**

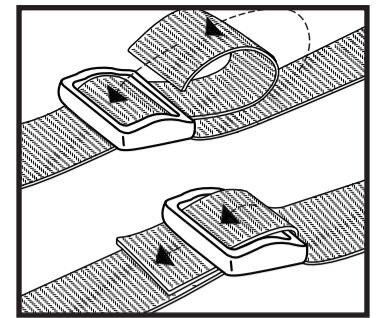

Tri-glide buckles may be locked into place (preventing shifting, sliding, etc.) by threading the tail-end of the strap back through the far end of the buckle, as shown. Straps with extra length after adjustment may be carefully trimmed and the edges melted to prevent fraying.

Before trimming, ensure that the adjustments are correct, and remember to take into account changes in seasonal clothing or body armor that may require sling adjustments.

**REPAIRS**

Great care was taken to select the finest materials available to craft your Galco product. It was designed in accordance with the highest engineering standards and hand made using traditional leather craft practices that have become Galco hallmarks over five decades. In the unlikely event a repair is necessary to an unaltered Galco product, simply contact our Customer Service department at **800-874-2526** or [customerservice@galcofirearm.com](mailto:customerservice@galcofirearm.com). We will issue you a Return Authorization (RA) number to print on the outside of your shipping container and provide you with detailed shipping instructions.

**TERMS OF SALE**

Because we have no control over the use of our products, all Galco products are sold as is and "with all faults". The entire risk as to the quality and performance of the product is with the buyer. Should the product prove defective following its purchase, the buyer and not the manufacturer, distributor, or retailer assumes the entire risk of all the necessary servicing or repairs. Under no circumstances shall Galco be liable for incidental or consequential damages, such as loss of use of property, commercial loss and loss of earnings or profits. The implied warranties of merchantability and fitness for a particular purpose and all other warranties, expressed or implied, are excluded from this transaction and shall not apply to the product sold. The determination of the fitness or the suitability of any product for a specific use is the responsibility of the buyer. The illustrations shown herein are typical as to the finish and application. Due to uncontrollable variances in color saturation, the actual product may differ slightly from that shown on our web site. Galco reserves the right to make changes in product built and/or sold by them at any time without incurring any obligation to make same or similar changes on products previously manufactured and/or sold by them. All Galco products are made in the U.S.A. and produced according to rigid specifications. Prices and models are subject to change without notice. Some states do not allow the exclusion or limitation of implied warranties or liability for incidental or consequential damages, so the above limitations and exclusions may not apply to you. Galco designs, features, and model names are the exclusive property of Galco International. Any and all persons including, but not limited to, individuals, firms and/or corporations are forbidden from imitating, copying or reproducing them in any way.

**⚠ WARNING** Keep your finger off the trigger until your sights are on the target!!

**⚠ WARNING** Do not attach a loaded firearm to a sling without first testing – with a firearm double-checked and verified to be unloaded – for proper firearm fit.